

**131PE001C1**

**PORSCHE 911 Carrera RWD  
992**

**ASP**

ADJUSTABLE SPRING PERCH

**BC**



Thank you for purchasing the BC Racing A.S.P.  
Please read this instruction guide carefully before proceeding with install.

<b>BC Part Number</b>	<b>131PE001C1</b>
Vehicle	PORSCHE 911 Carrera RWD
Model/Chassis	992
Year	2019+
Min. Ride Height from OEM	FRONT -31mm
	REAR -35mm
TIRE SIZE FRONT	255/35/20
TIRE SIZE REAR	315/30/21

▲ All vehicle lowering data is for reference only and may vary depending on individual vehicle conditions.

 **Disclaimer**

The BC Racing ASP is designed and intended to lower a vehicle's ride height. The use of this product on public roadways may not meet local, state, or federal regulations. Installation and use of this product may affect the vehicle's original manufacturer's warranty. It is the consumer's responsibility to meet and comply with federal, state, or local government regulations and/or policies prior to operating the vehicle on public roadways.









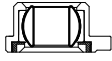

**ATTENTION!!**

Removal of OEM components from damper assemblies and installation of this product may only be undertaken by trained technical personnel with ASE certification.

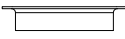
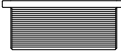



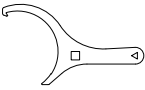

Incorrect installation/adjustment can damage OEM Dampers or other OEM components, which we are not able to supply. Installers shall be responsible for any damage due to incorrect installation or adjustment.

## Parts List

### FRONT

SA13-0044		TOP NUT	2
SAAY-0014		CAMBER PLATE	2
SA02-1024		CAMBER BEARING HOUSING	2
SA09-0021		UPPER SPRING SEAT	2
SA09-0023		UPPER PLATE	2
SG07-2220		SPRING PERCH	2
SG09-1109		LOCKING RING	2
SA15-6004		M6 SET SCREW	2
SA11-2019		DUST COVER	2
SA11-0031-25		BUMPSTOP	2
1-SPS-2103.2-A2		SPRING	2
SG12-0074		SPANNER	1

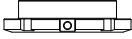
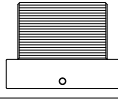
### REAR

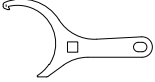
SA09-1224		UPPER SPRING SEAT	2
SA11-2019		DUST COVER	2
SA11-0030-14		BUMPSTOP	2
1-SPS-2257.7-A1		SPRING	2
SG09-1117		LOCKING RING	2
SG07-2219		SPRING PERCH	2
SA15-6002		M5 SET SCREW	6
SA15-6004		M6 SET SCREW	2
SG12-0075		SPANNER	1

## Before Installation



### CAUTION

- This product was designed and developed for specific vehicle models and should only be installed on the intended application. Ensure you received the correct items for your vehicle before attempting installation.
- No part of this instruction may be reproduced or transmitted in any form or by any means, electronic or mechanical, including photocopying, recording, or by any information storage and retrieval system, without express written permission from Taiwan Bor-Chuann Enterprise Co., Ltd.
- **This product may only be installed by trained technical personnel with ASE certification.**
- Do not use impact wrenches to install or remove damper/shock absorber hardware.
- Installation and removal of suspension components including dampers and springs must be in accordance with the original manufacturer's specifications. Please refer to the factory service manual if available.
- BC (Taiwan Bor-Chuann Enterprise Co., Ltd) is not liable for any damages and/or failures caused by the use of components not supplied by BC (Taiwan Bor-Chuann Enterprise Co., Ltd).
- Incorrect installation or adjustment can cause noise and/or damage to the product, which will not be covered by warranty.

## ARROW INDICATION

- INSTRUCTION
- BC SUPPLIED ASP PARTS
- OEM PARTS

## Installation FRONT

1

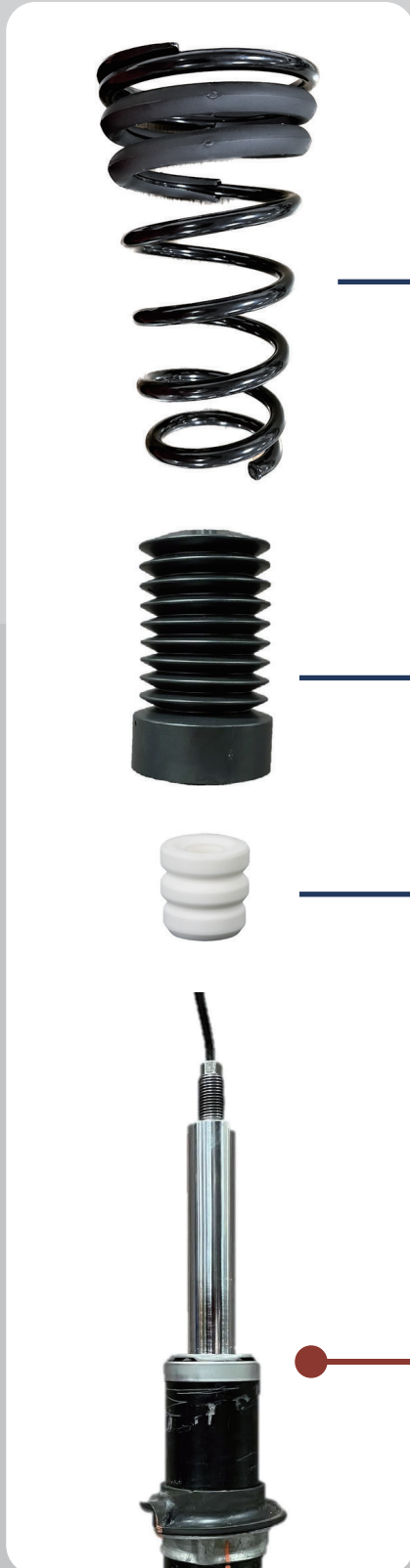

Install the following parts in order onto the OEM shock after you remove the OEM top mounts, bearing, spring and upper spring seat :

1. BC ASP bump stop  
↓
2. BC ASP dust cover  
↓
3. BC ASP coil spring

## 2

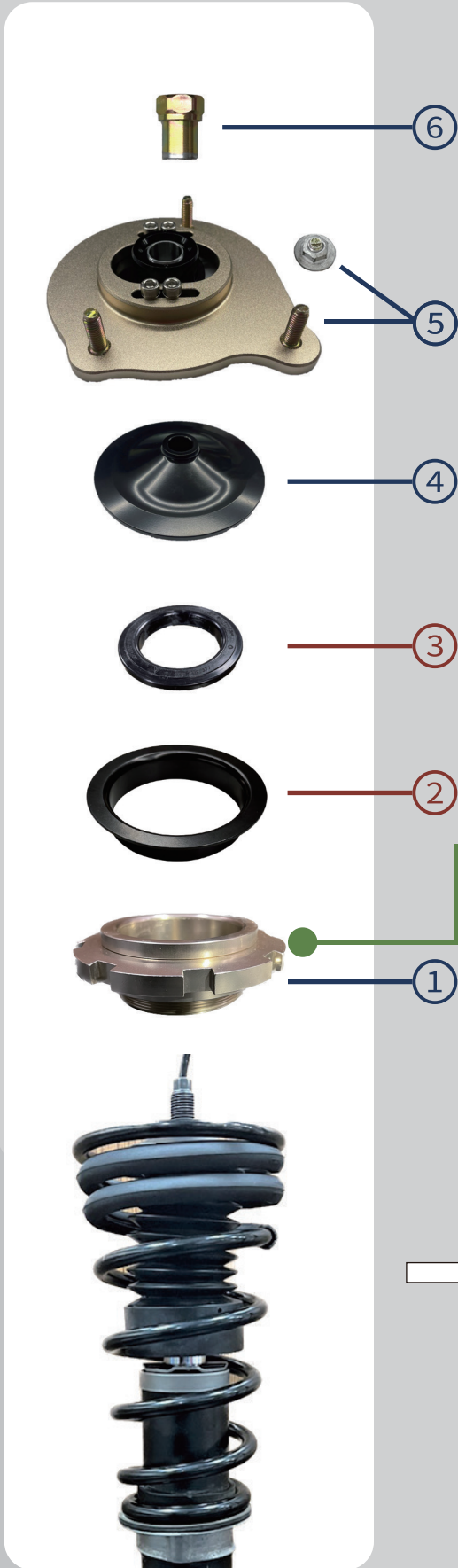

Continue to install the following parts in order :

1. BC ASP spring perch



2. BC ASP upper plate



3. OEM bearing



4. BC ASP upper spring seat



5. BC ASP camber plate **(Reuse OEM stud nuts)**



6. BC ASP top nut

(M14, with 70Nm of torque)

## 3

Tighten the M6 set screw on the side of the locking ring after installation.



## Installation REAR

# 4



Move the shock retaining ring from the 4th groove to the 5th.

Install the following parts in order :

1. BC ASP bump stop  
↓
2. BC ASP spring perch  
↓
3. BC ASP dust cover  
↓
4. BC ASP coil spring

# 5

Tighten the three M5 set screws after installation of the spring perch. Don't forget to tighten the M6 set screw on the side of the locking ring.

M5 Set Screw x 3



## 6



Continue to install the following parts in order:

1. BC ASP upper spring seat  
↓
2. OEM rear top mount  
↓
3. OEM rear top nut  
(M12, with 50Nm of torque)





- Do not over tighten damper top nuts. All hardware should be tightened in accordance with the recommended torque values specified in the vehicle manufacturer's manual.

## Adjustment

- Do not over tighten the spring as this will compress spring and cause rate shifting.
- Always clean dirt and debris from threads with pressurized air and/or brake cleaner. It is recommended to grease adjuster threads before performing ride height adjustments to prevent locking rings from seizing.

## After Installation

- Make sure all hardware that was removed during installation are properly tightened.
- Ensure the set screw on each locking ring is tightened.
- A full vehicle alignment is highly recommended after installation, as it greatly influences the vehicle's handling characteristics and tire wear.
- Perform regular periodic checks on all hardware and locking rings.

## Technical Support

- Please keep the original purchase invoice and warranty card for future service requests.
- Lowering your vehicle will change chassis suspension geometry. This can lead OEM components such as control arms, to generate noise. Relative age and condition of the surrounding suspension components may exacerbate noise production, commonly referred to NVH (noise, vibration, harshness).
- Please contact your local distributor for more information concerning technical support or advice concerning the product.

**ASP**

ADJUSTABLE SPRING PERCH

**BC**



 [bc@bcec.com.tw](mailto:bc@bcec.com.tw)

 [www.bcec.com.tw](http://www.bcec.com.tw)